

JILK-N



Ventilator za kružne kanale i opštu vrentilaciju. Kućište, radno kolo i nosač su napravljeni od pocinkovanog čelika. Ventilatori se isporučuju sa nosačem i priključnom kutijom. Može da se ugradi i da radi u bilo kom položaju.

Fan for circular ducts and general ventilation. Housing, impeller and bracket are made of galvanized steel. Fan is supplied with terminal box and brackets. Fan can be installed and operate in any position.

Materijal / Material

Pocinkovan čelik
Galvanized steel

Pakovanje / Package

1 kom
1 pc

Klasa zaštite motora / Motor ingress protection class

IP44

Klasa izolacije motora / Motor isolation class

F za model 355, za ostale modele B
F for model 355, for other models B

Regulisanje brzine / Speed control

Regulator brzine REM 2,5
Rheostat REM 2,5

Napajanje/ Power supply

Monofazno 230V/50-60Hz
Single phase 230V/50-60Hz



TEHNIČKI CRTEŽI I TABELE TECHNICAL DRAWING AND TABLES

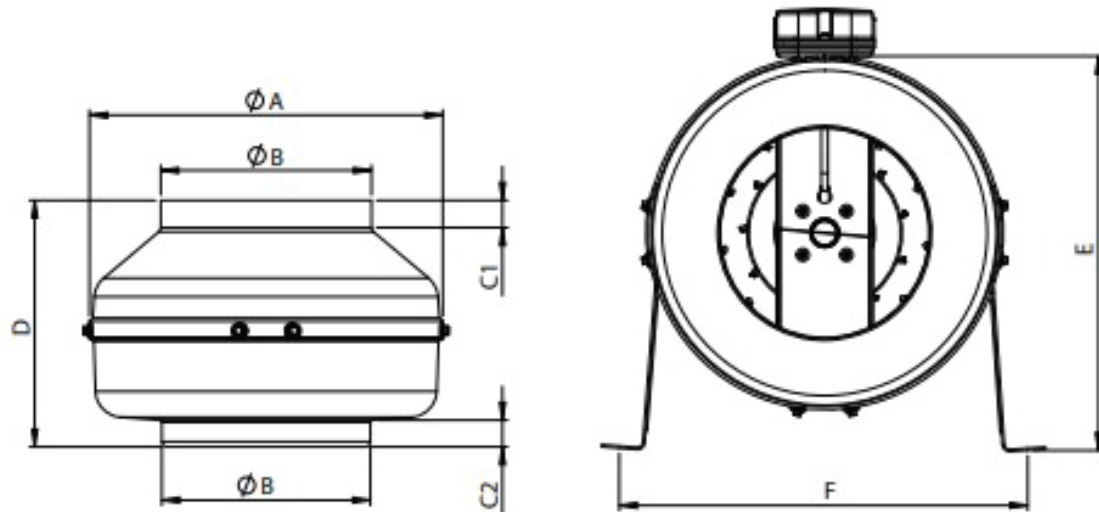

TIP TYPE	A	B	C1	C2	D	E	F
JILK 100 N	245	97	20	20	197	273	268
JILK 125 N	245	122	20	20	188	273	268
JILK 150 N	272	147	23	25	192	286	295
JILK 160 N	272	157	23	25	192	286	295
JILK 200 N	330	196	30	28	230	380	352
JILK 250 N	330	247	30	28	227	380	352
JILK 315 N	400	313	30	30	285	415	422
JILK 355 N	400	352	30	30	378	415	422

*Dimenzije su izražene u mm





TEHNIČKA SPECIFIKACIJA TECHNICAL SPECIFICATION

Model	Napajanje [V/50Hz]	Snaga [W]	Jačina struje [A]	Kondezator [μf]	Brzina [r.p.m]	Protok [m³/h]	Jačina buke [dB(A)]	Regulacija
JILK 100 N	230/50-60	60	0,30	2	2.610/2.960	240/275	44	REM 2,5
JILK 125 N		80	0,40	2,5	2.325	315	43	
JILK 150-B N		78	0,40	2,5	2.425	420	46	
JILK 160-A N		85	0,40	2,5	2.550	440	45	
JILK 200-A N		90	0,43	2,5	2.300	735	46	
JILK 200-B N		100/130	0,51/0,68	4	2.530/2.720	870/935	48	
JILK 250-A N		140	0,69	4	2.400	1.010	45	
JILK 250-B N		145/200	0,74/1,04	6	2.635	1.150	47	
JILK 315-A N		160/210	0,8/1,1	6	2.400	1.450	48	
JILK 315-B N		180/245	0,87/1,23	7	2.500/2.700	1.750/1.890	49	
JILK 355-A N		160/175	1/0,85	4	1.450/1.700	1.300/1.525	45	
JILK 355-B N		445	1,94	8	2.450	2.620	54	

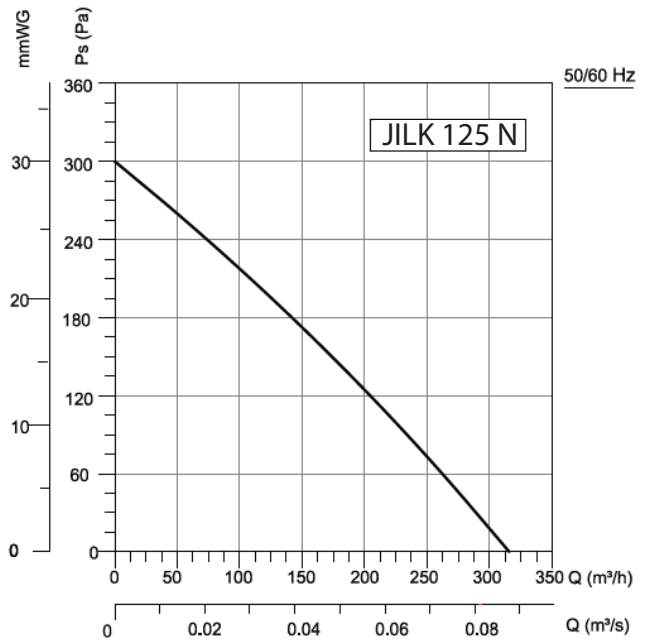
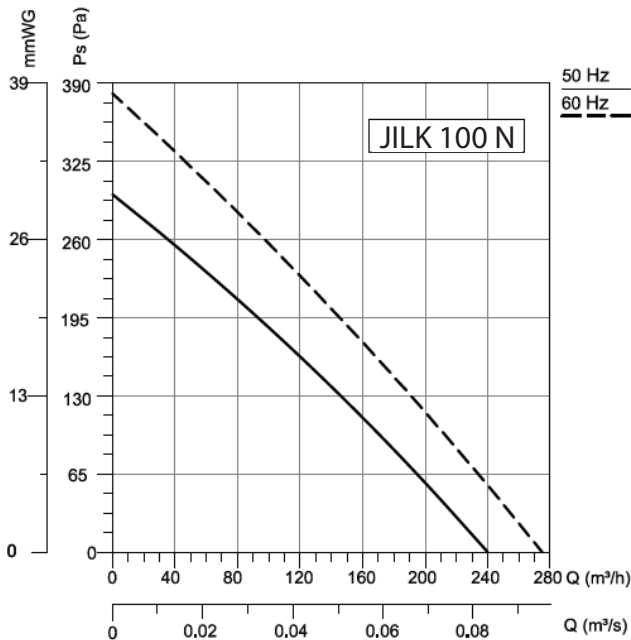

TEHNIČKA SPECIFIKACIJA TECHNICAL SPECIFICATION

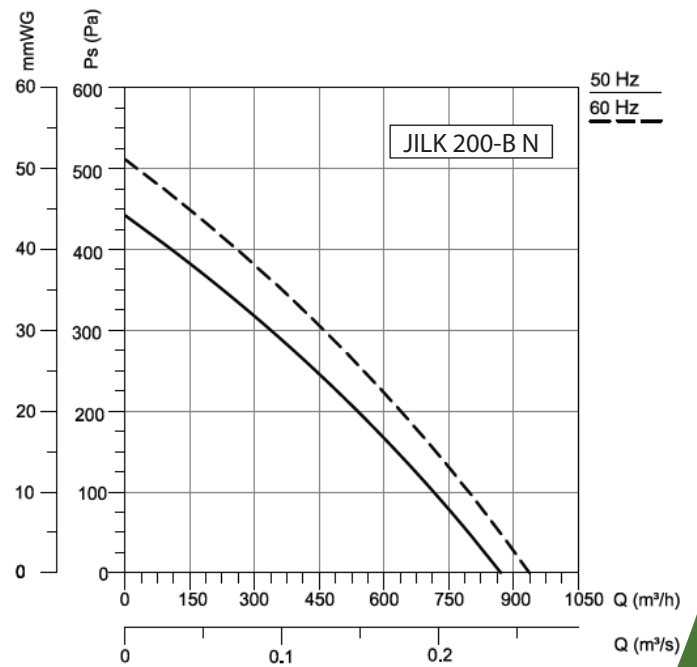
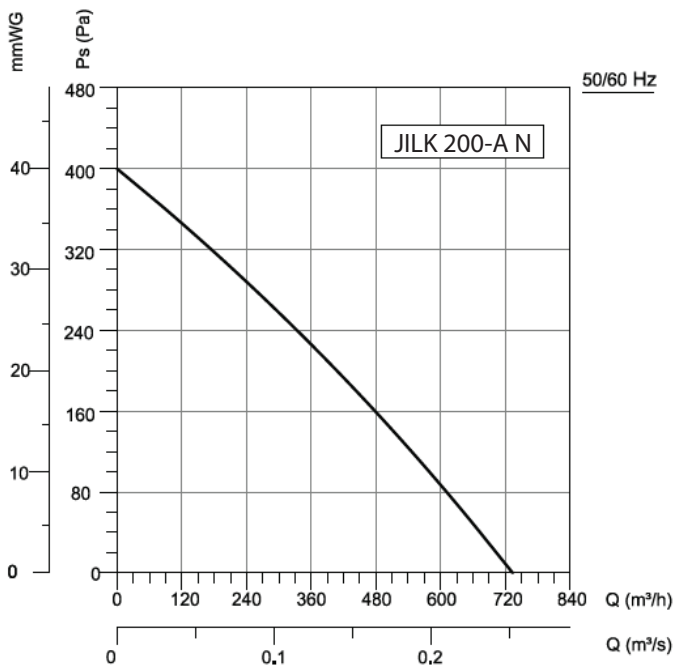
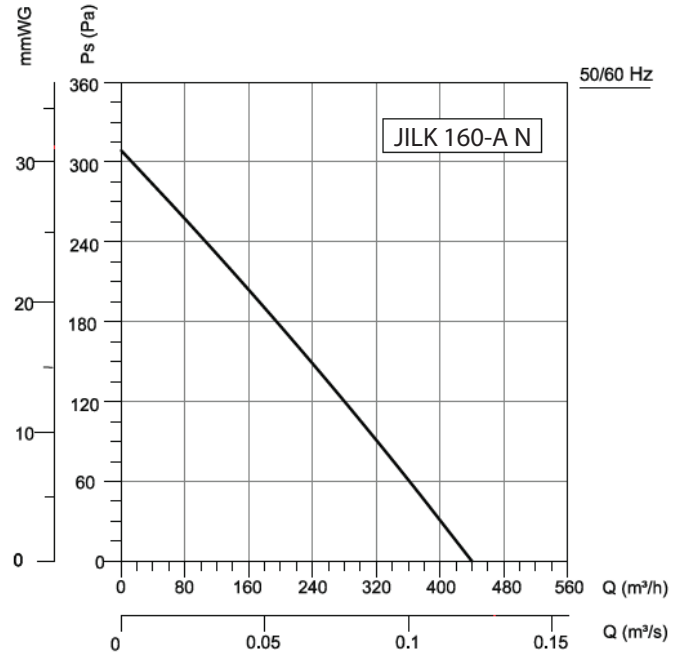
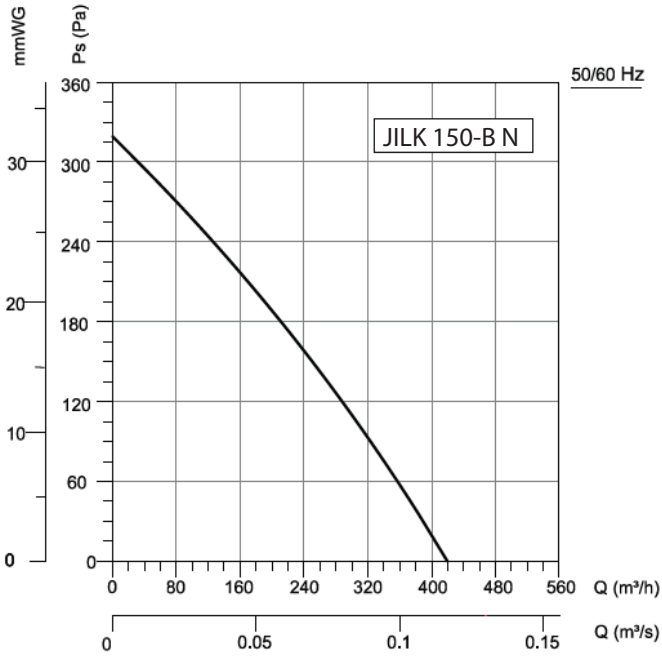



TEHNIČKA SPECIFIKACIJA TECHNICAL SPECIFICATION

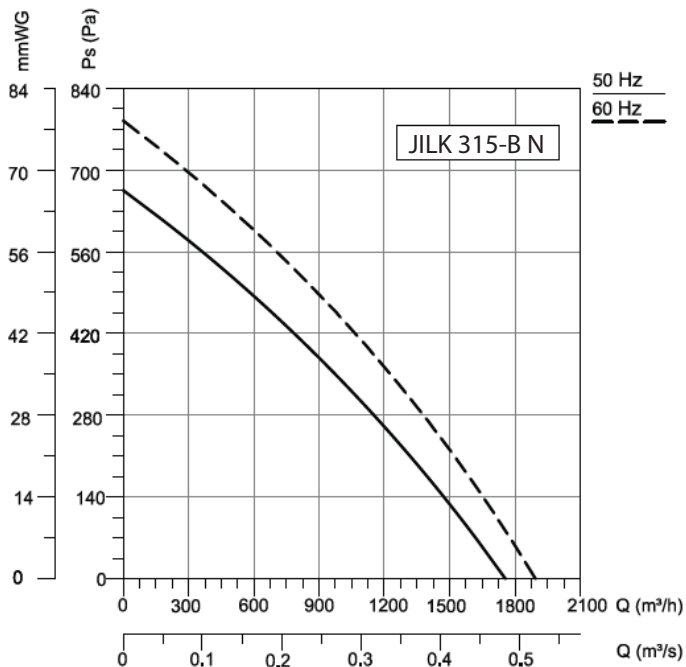
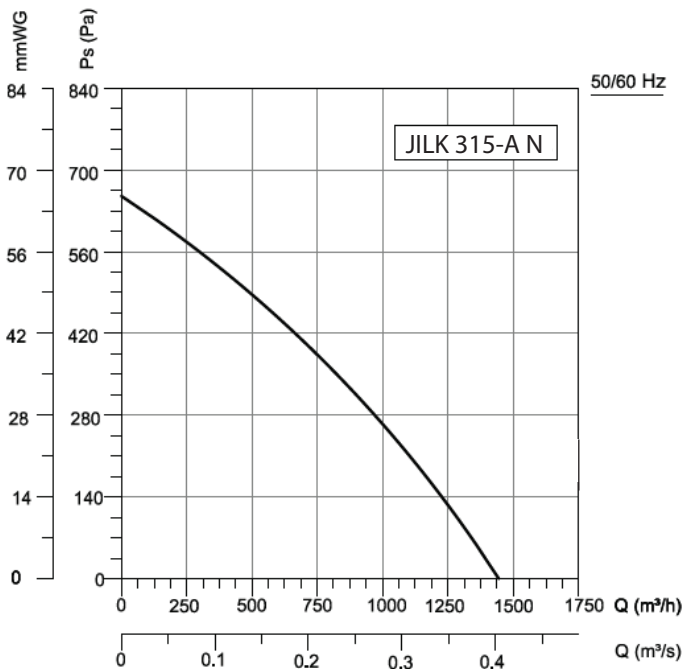
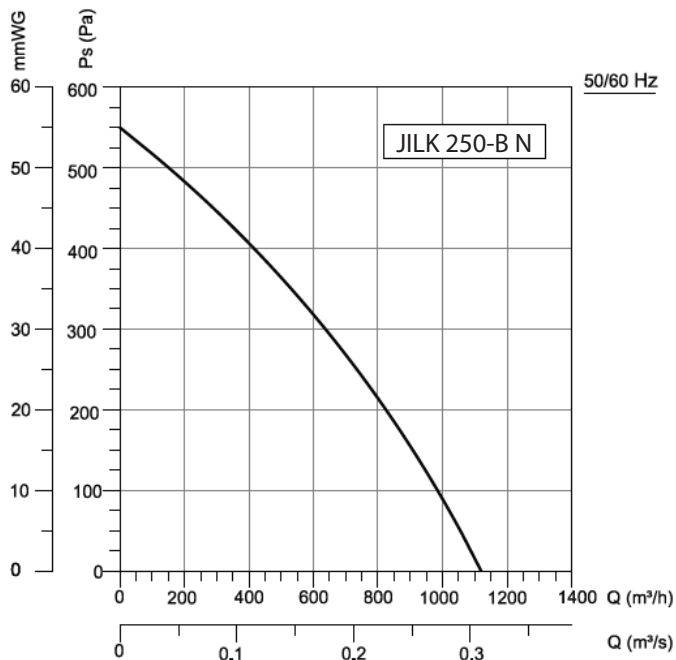
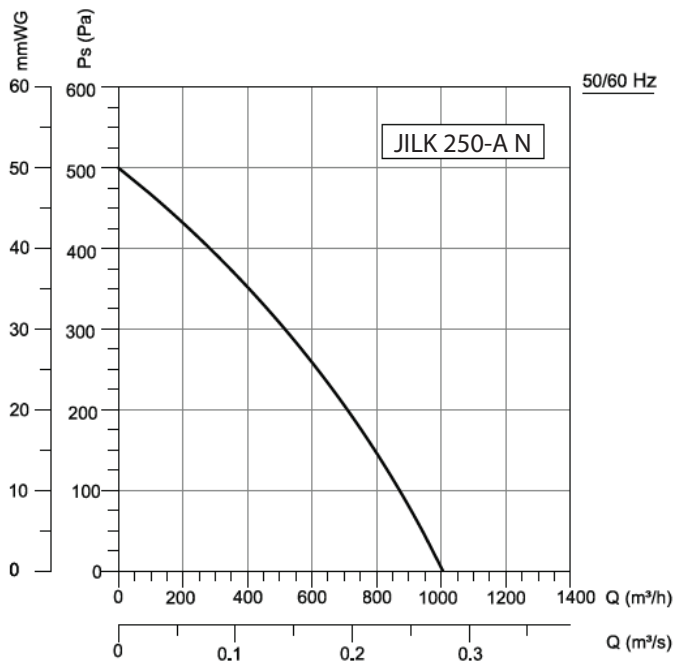

TEHNIČKA SPECIFIKACIJA TECHNICAL SPECIFICATION

