

ELECTRIC HEATER WIRING DIAGRAM

VOLTAGE	380 V / 50 Hz	ELECTRIC HEATER	ELEKTRIČNI GREJAČ JEGK
POWER	3 kW		
CURRENT			
		170x270x200; 3kW; 380V; 2 stepeni	

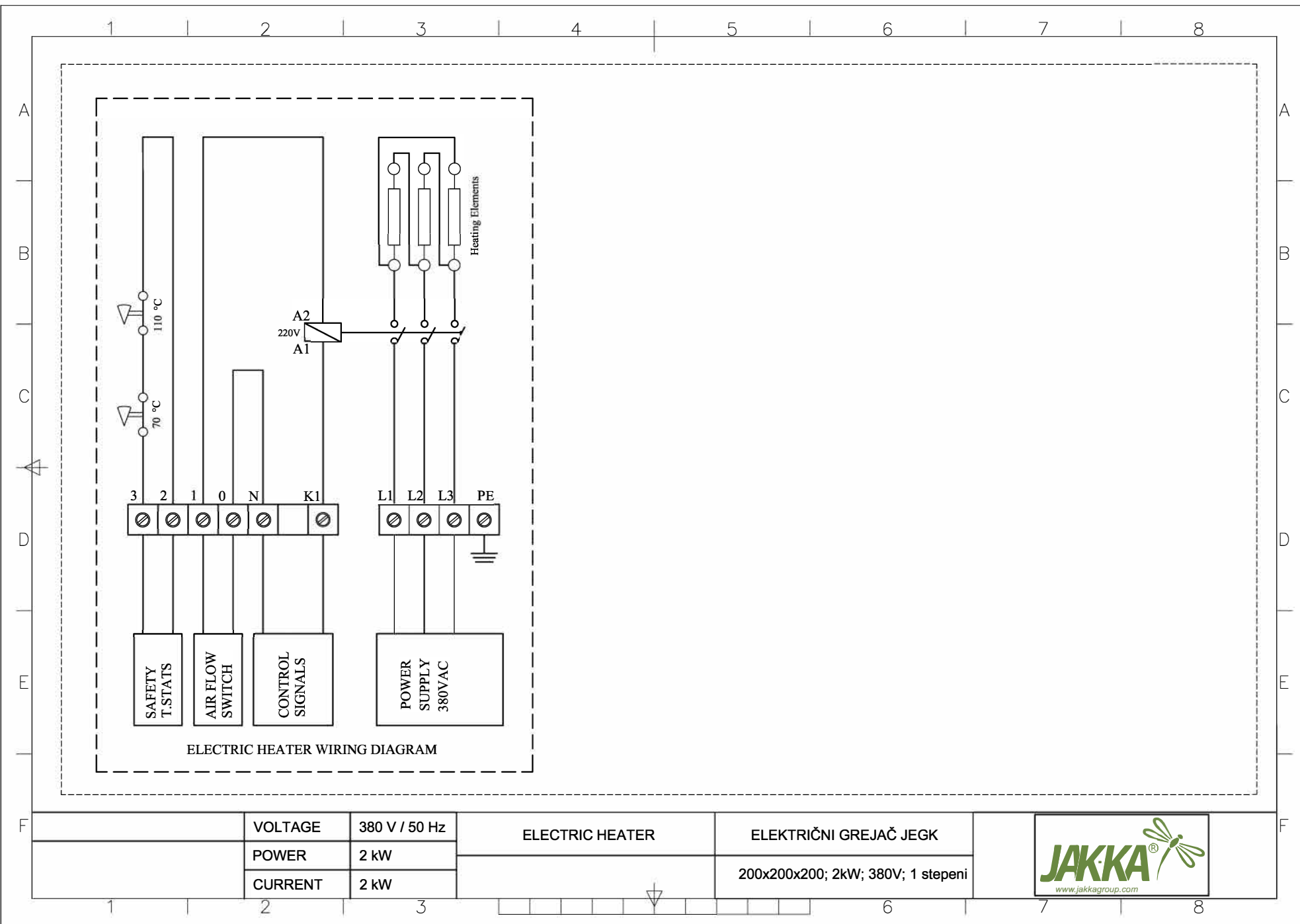



ELECTRIC HEATER WIRING DIAGRAM

	VOLTAGE	380 V / 50 Hz	ELECTRIC HEATER	ELEKTRIČNI GREJAČ JEGK
	POWER	2 kW		
	CURRENT	2 kW		
				200x200x200; 2kW; 380V; 1 stepeni



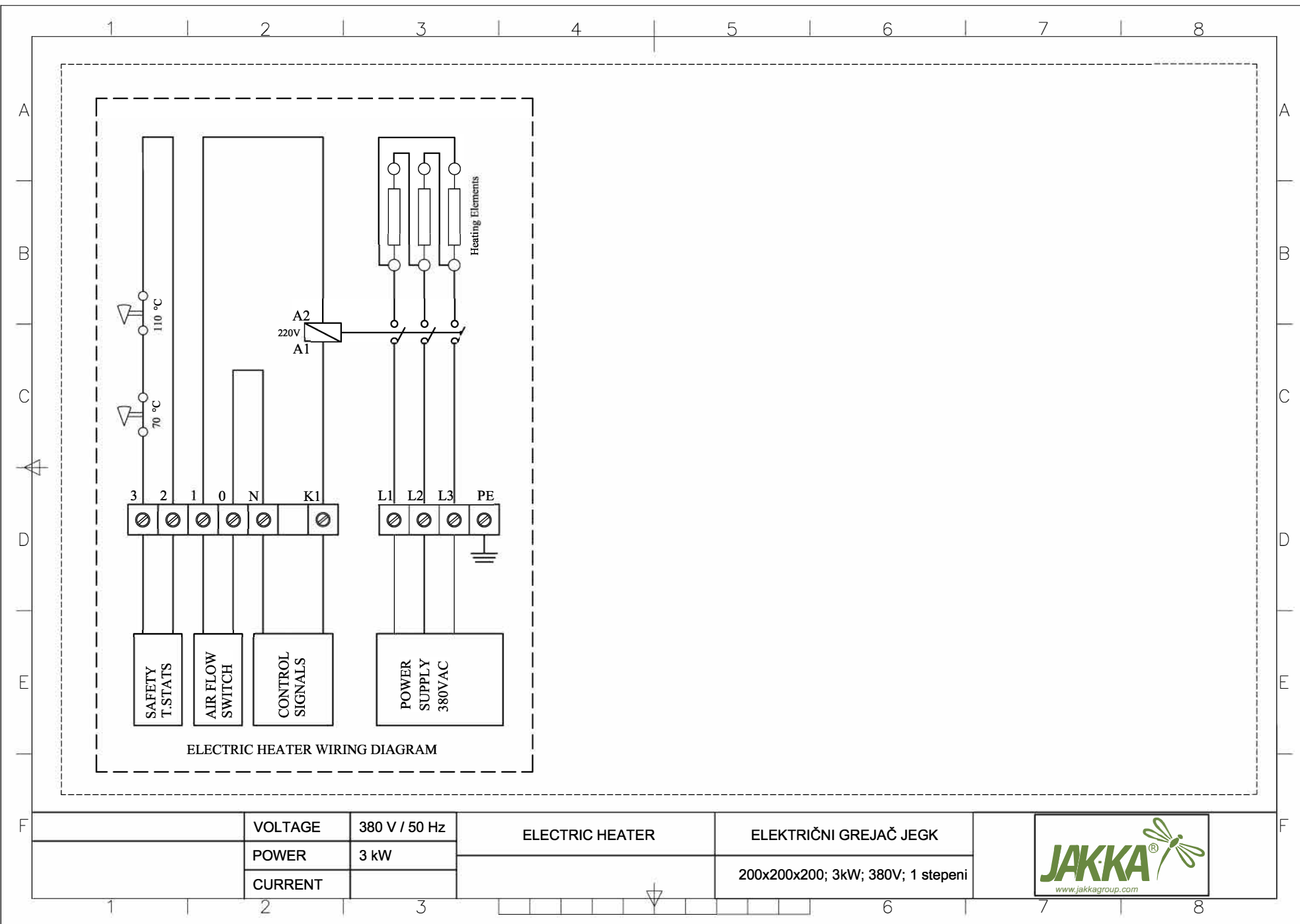

ELECTRIC HEATER WIRING DIAGRAM

	VOLTAGE	380 V / 50 Hz	ELECTRIC HEATER	ELEKTRIČNI GREJAČ JEGK
	POWER	3 kW		
	CURRENT			
			200x200x200; 3kW; 380V; 1 stepeni	



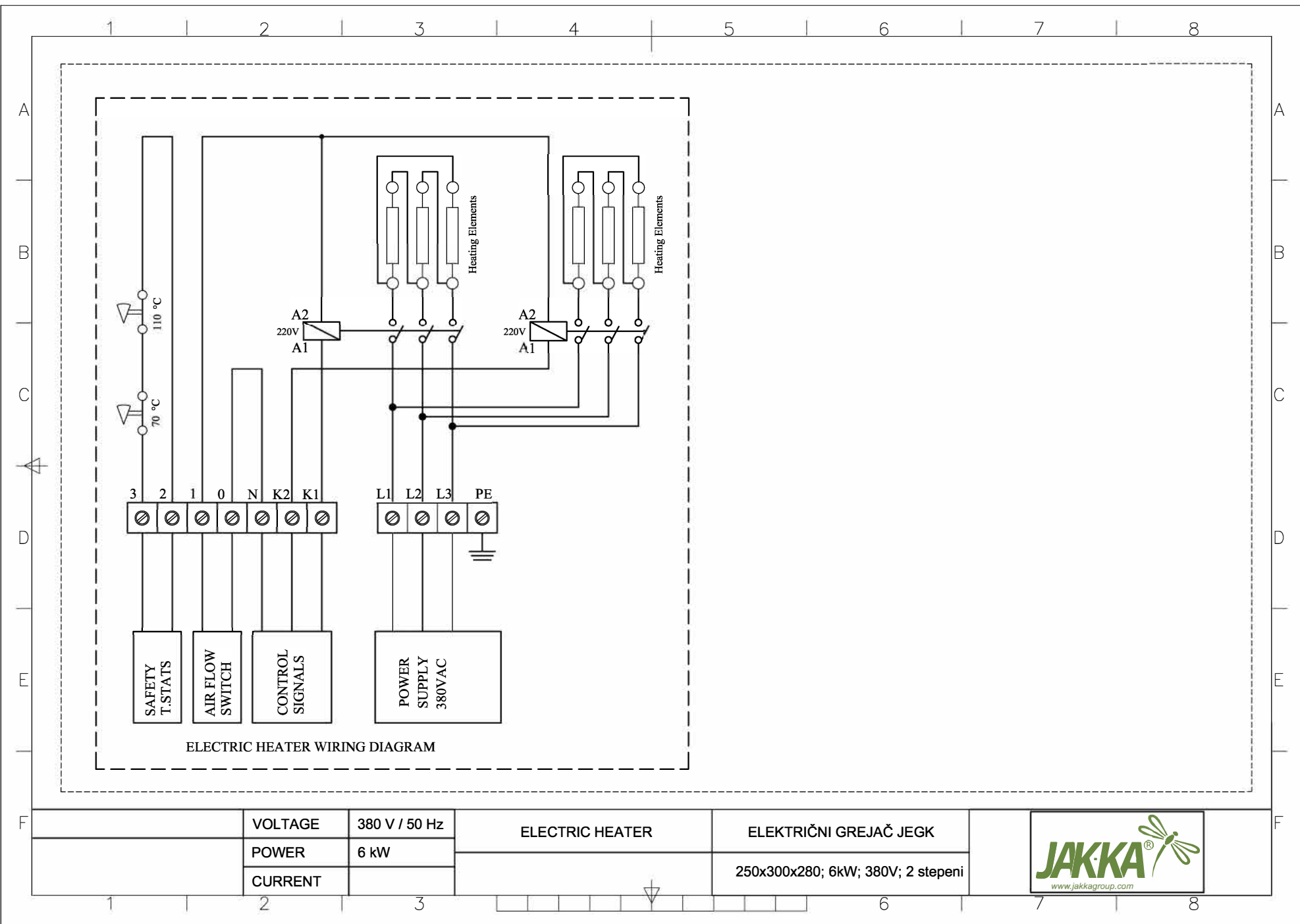

ELECTRIC HEATER WIRING DIAGRAM

VOLTAGE	380 V / 50 Hz
POWER	6 kW
CURRENT	

ELECTRIC HEATER

ELEKTRIČNI GREJAČ JEGK

250x300x280; 6kW; 380V; 2 stepeni



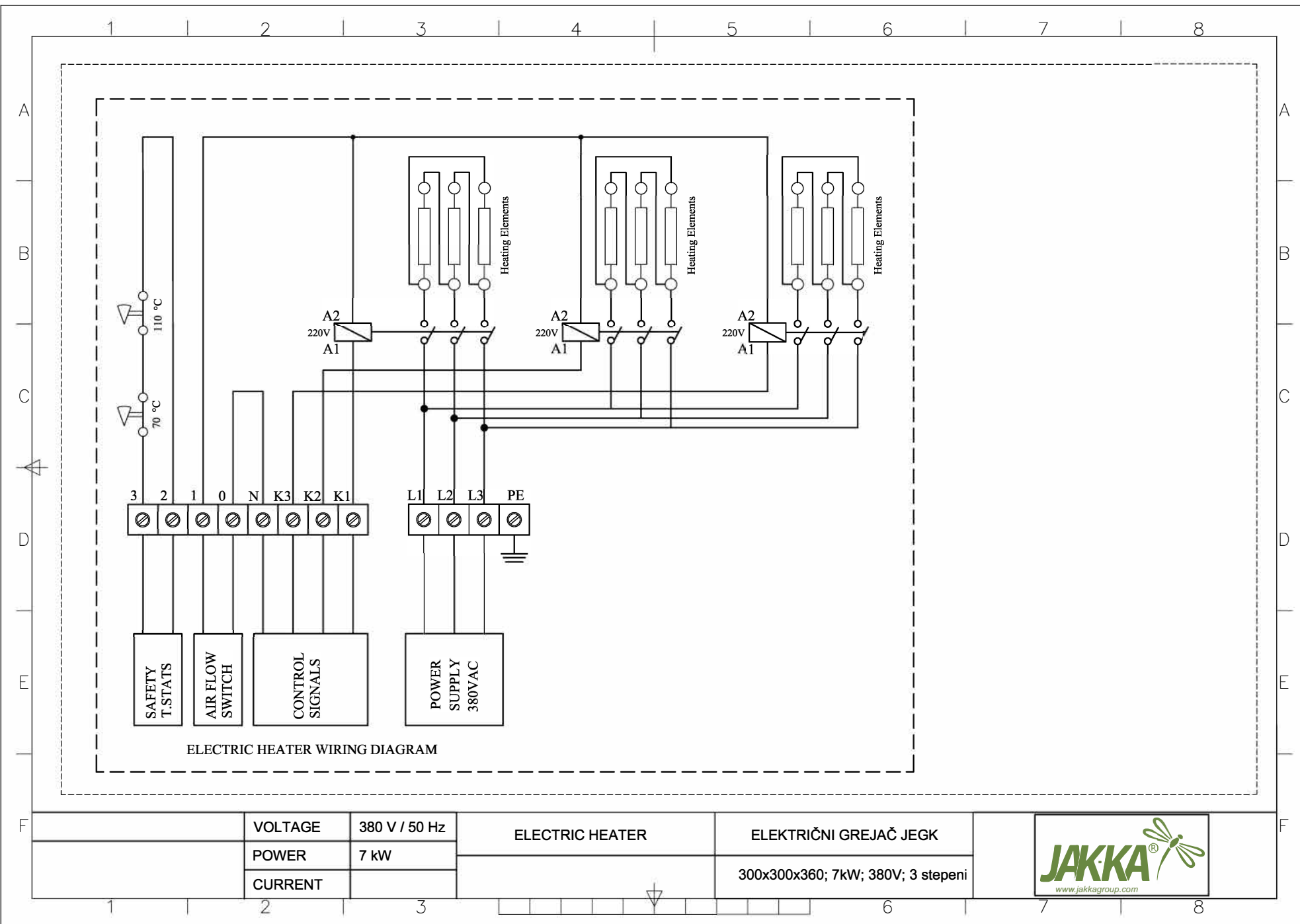

ELECTRIC HEATER WIRING DIAGRAM

VOLTAGE	380 V / 50 Hz
POWER	7 kW
CURRENT	

ELECTRIC HEATER

ELEKTRIČNI GREJAČ JEGK

300x300x360; 7kW; 380V; 3 stepeni



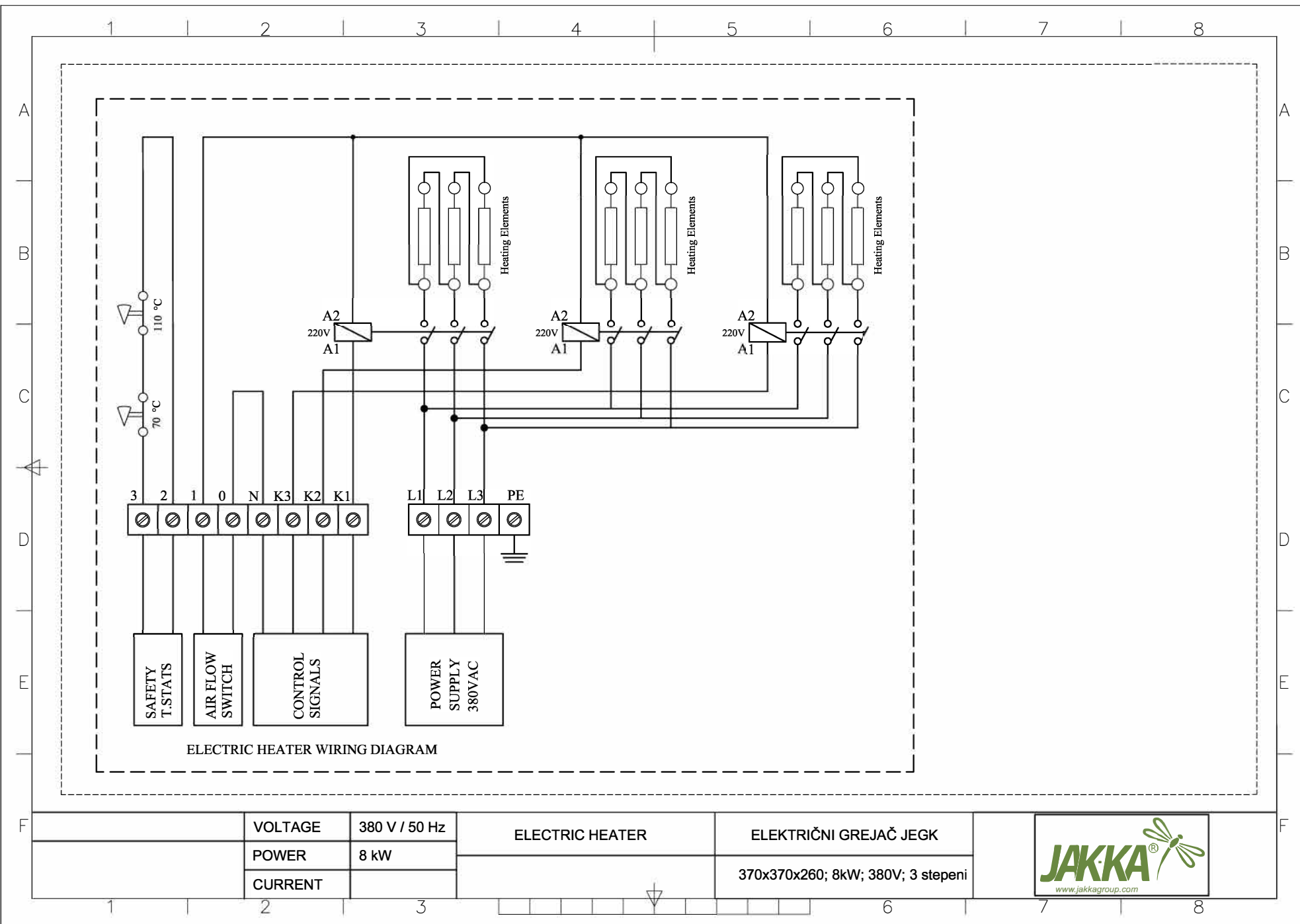

ELECTRIC HEATER WIRING DIAGRAM

VOLTAGE	380 V / 50 Hz
POWER	8 kW
CURRENT	

ELECTRIC HEATER

ELEKTRIČNI GREJAČ JEGK

370x370x260; 8kW; 380V; 3 stepeni



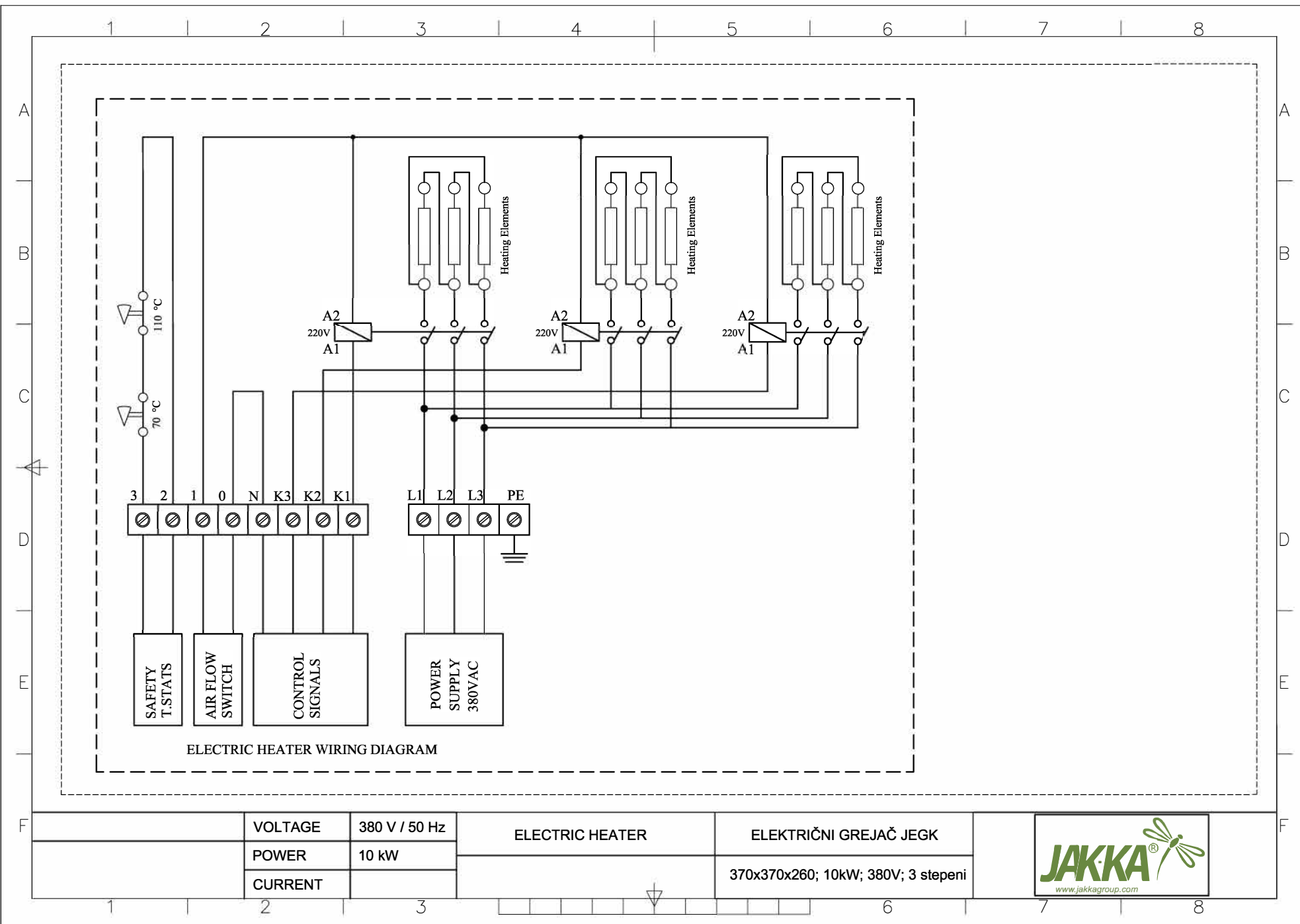

ELECTRIC HEATER WIRING DIAGRAM

	VOLTAGE	380 V / 50 Hz	ELECTRIC HEATER	ELEKTRIČNI GREJAČ JEGK
	POWER	10 kW		
	CURRENT			
			370x370x260; 10kW; 380V; 3 stepeni	



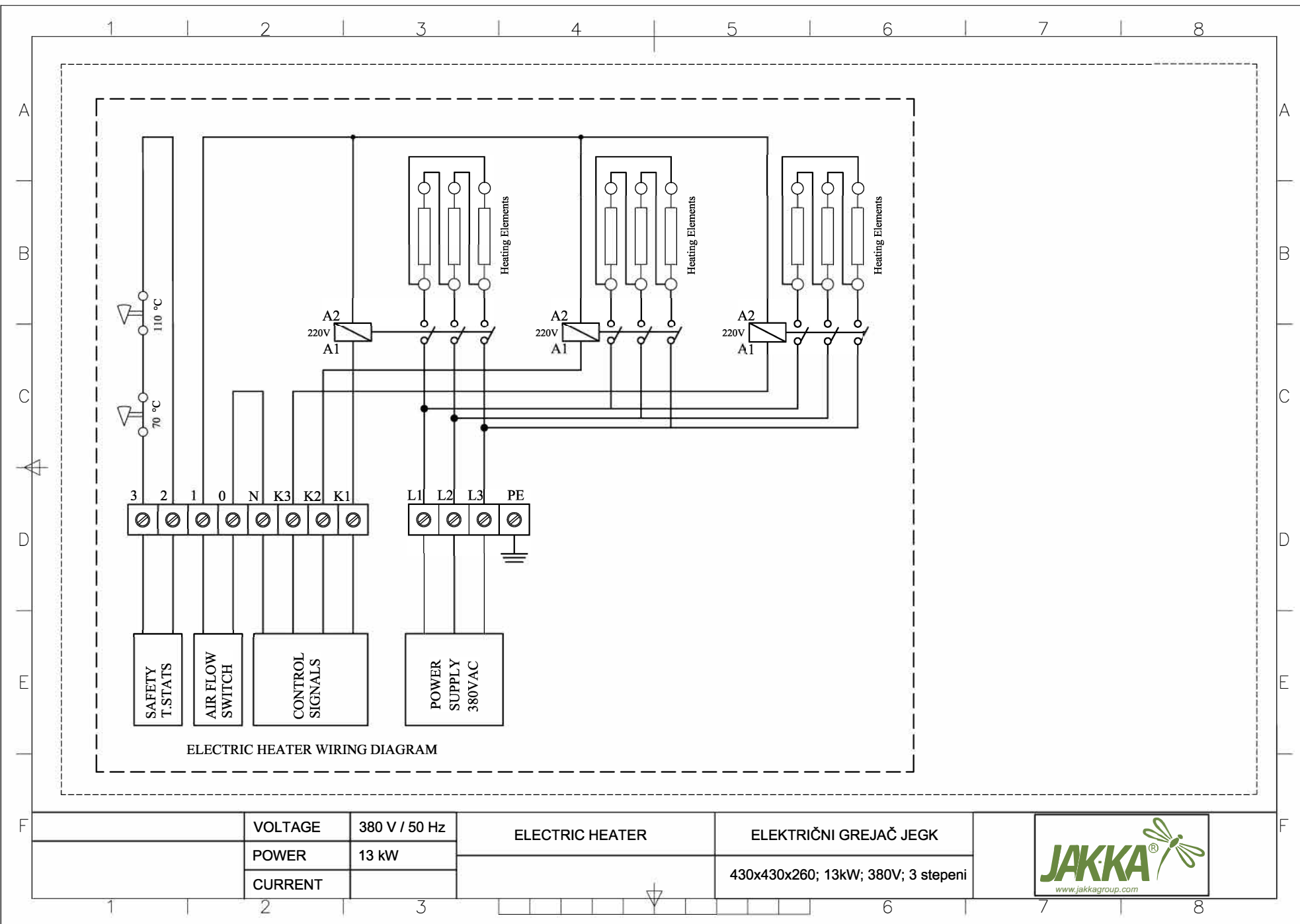

ELECTRIC HEATER WIRING DIAGRAM

VOLTAGE	380 V / 50 Hz
POWER	13 kW
CURRENT	

ELECTRIC HEATER

ELEKTRIČNI GREJAČ JEGK

430x430x260; 13kW; 380V; 3 stepeni



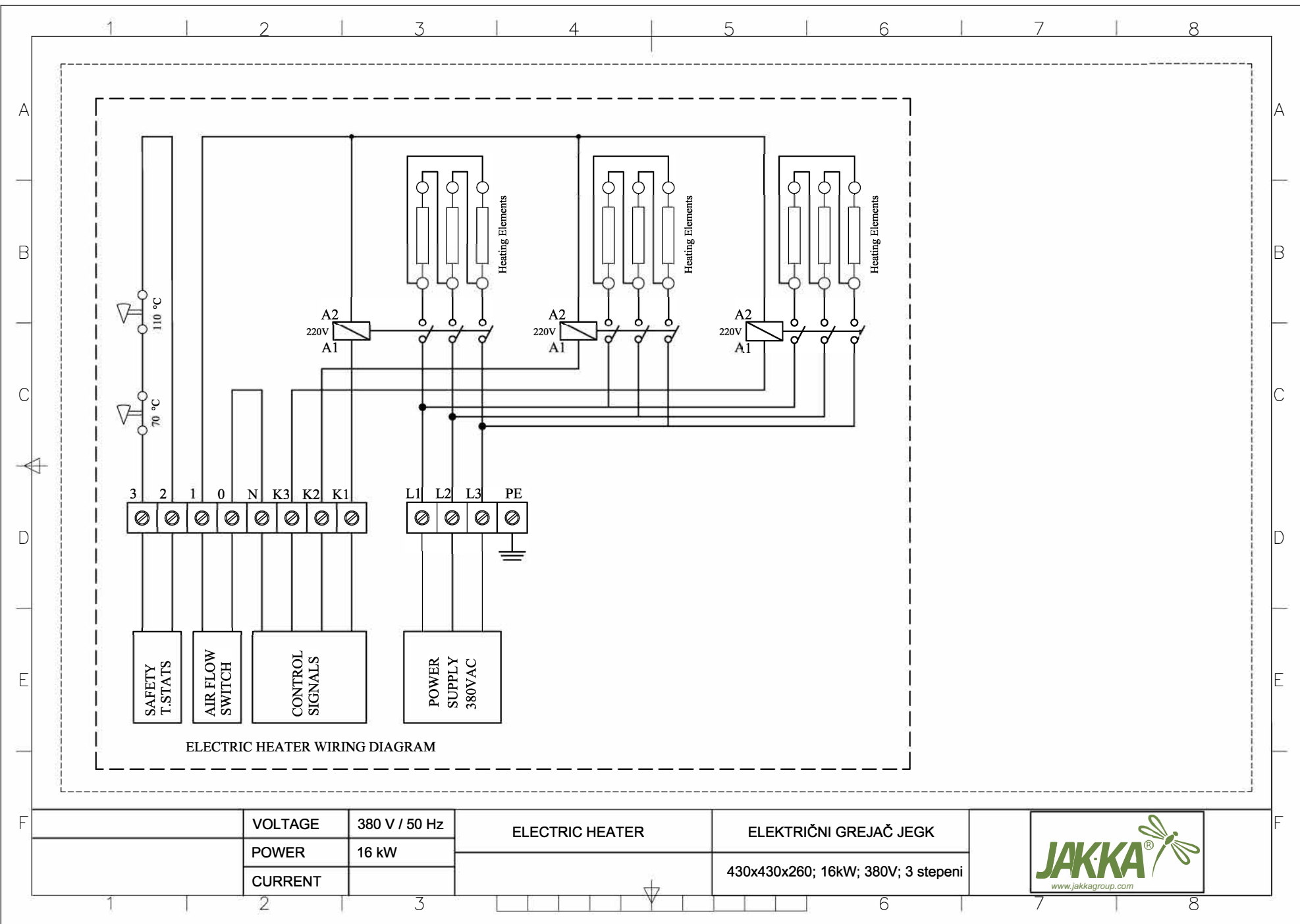

VOLTAGE	380 V / 50 Hz
POWER	16 kW
CURRENT	

ELECTRIC HEATER

ELEKTRIČNI GREJAČ JEGK
430x430x260; 16kW; 380V; 3 stepeni

