

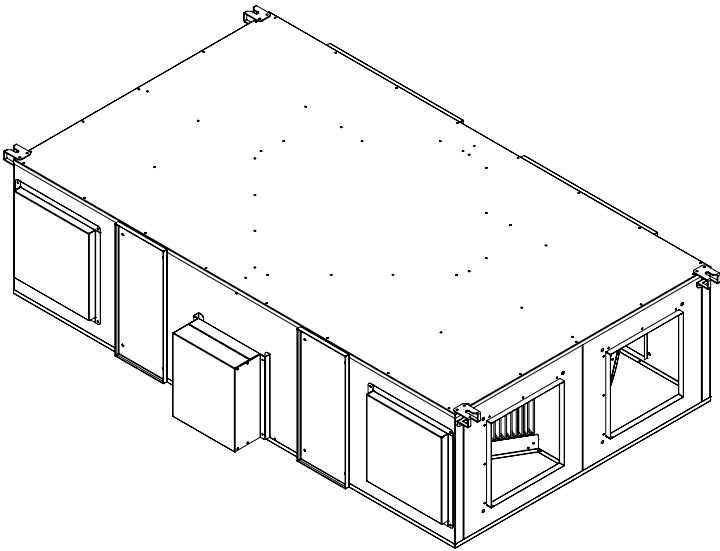

JAKKA Control Kit 4 quick instructions



Contents

Controls2
Troubleshooting7

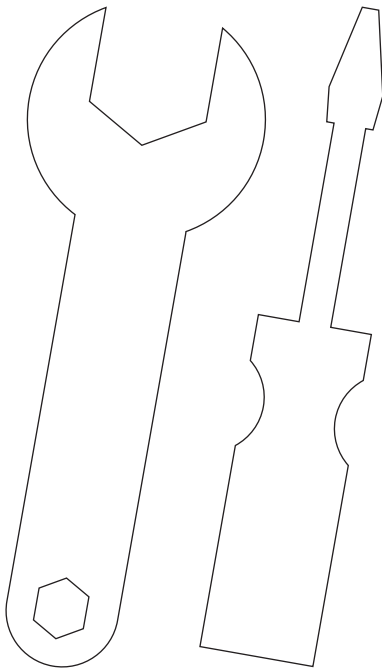

CONTROLS

► Button Functions

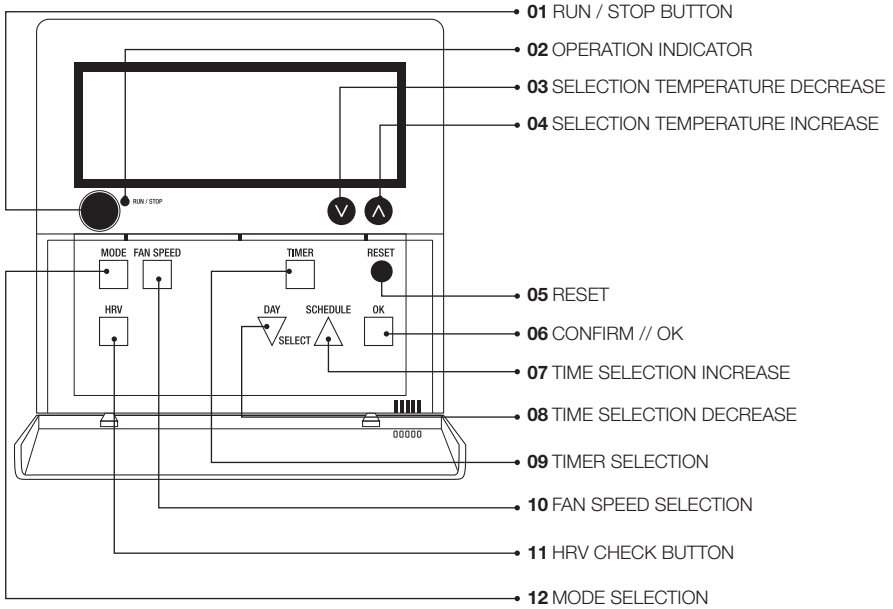

► LCD Functions

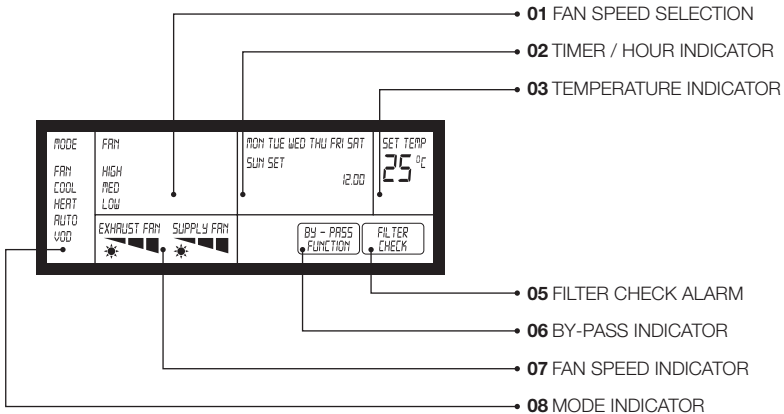

CONTROLS

Remote Control Functions

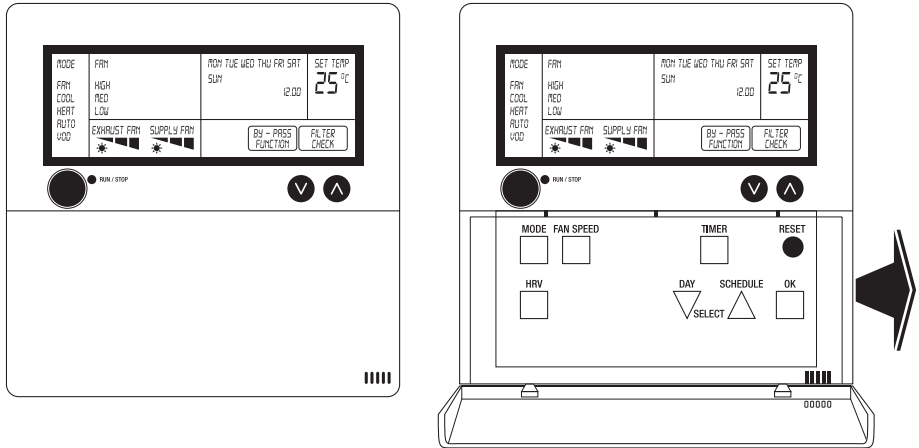

RUN / STOP

When the backlight and led is off, press the button once to turn the unit on.

When the unit is on press and hold RUN/STOP for 2 seconds to switch it off, and vice versa.

All buttons work if the RUN led is on or timer mode is active.

Button doesn't react if BMS is active.

In defreeze mode there is no interference possible, except turning off the unit.



Increase/decrease set point room temperature by 1°C (SET TEMP is on).

MODE

Press MODE button to select the listed modes of operation (FAN, COOL, HEAT, AUTO, VOD).

Every time a button is pressed a next mode will be selected, and after a 5 seconds delay, the mode will be activated. The text MODE on display is always visible.

FAN SPEED

With this button, fan speed of exhaust and supply fan can be changed.

- Press this button and EXHAUST FAN and current fan speed text start blinking.
- Use buttons to select fan speed (HIGH, MED, LOW) .
- Press OK to confirm.
- Now, SUPPLY FAN and current fan speed text start blinking.
- Use buttons to select fan speed (HIGH, MED, LOW).
- Press OK to confirm.

HRV

Press button to activate by-pass, when possible.

TIMER

Press and hold this button for 3 seconds and SET lights up on display, above the current time, as indicator that programming of unit operating time blocks begun. Outside the defined time blocks, the unit will not operate. It is possible to program up to 2 operating periods per day.

TIMER + MODE

Press and hold for 2 seconds both buttons to activate previously programmed TIMER option, and on display MODE text is blinking in the left upper corner.

CONTROLS

TIMER + FAN SEED

Press and hold for 2 seconds both buttons to show information on display about Modbus address. 'addr' text is shown in position where should be current time, and on position where should be temperature shown, now is showing address of Modbus '- -', and it means that controller is retrieving the Modbus address.

RESET

Press this button to reset filter check counter when on display FILTER CHECK lights up in bottom right corner. Default Filter Check counter is set to 1200 working hours.

LCD Functions





CHANGE TIME

- Press OK button for 3 seconds, time starts blinking.
- Change time with ▲ ▼ buttons. Time starts to change faster if buttons are pressed for a while.
- Press OK to confirm, current day starts blinking.
- Change day with ▲ ▼ buttons.
- Press OK to confirm.

Press RUN/STOP to stop immediately and go back to normal operation

TIMER FUNCTION

The TIMER function can be used to program unit operating time blocks in which the unit will operate. Outside the defined time blocks, the unit will not operate. It is possible to program up to 2 operating periods per day.

- Press TIMER button for 3 seconds, day MON starts blinking, all other LCD segments are off.
- Press DAY button (one or more times) to select the day to be set.
- Press OK to confirm, the selected day is permanent on.
- The temp display shows  which means that 1st "on" time block can be programmed.
- Adjust the "on" time with the DAY and SCHEDULE buttons, press OK to confirm.
- Next, 1st "off" time block can be programmed, the temp display shows .
- Again adjust the "off" time with the DAY and SCHEDULE buttons, press OK to confirm.
- Next, 2nd "on" time block can be programmed, the temp display shows .
- Adjust the "on" time with the DAY and SCHEDULE buttons, press OK to confirm.
- Next, 2nd "off" time block can be programmed, the temp display shows .
- Again adjust the "off" time with the DAY and SCHEDULE buttons, press OK to confirm
- Now the next day starts blinking and can be programmed accordingly as described above.
- To exit the programming mode, press and hold OK button for 3 second or wait 1 minute.

ADDITIONAL FEATURES

- A specific operating time can be deleted by pressing RESET button when programming unit operating time blocks. If deleted the time display shows:  and the time is not used.
- When, for example, the unit have programmed "on" time on Monday and no "off" time for that day, the unit remains "on" until the first "off" time is reached in following day(s). The same rule is used when the unit reach "off" state and have no "on" state programmed in following day(s).

CONTROLS

Example 1 – Normal Blocks

MON

Time display

Temp Display



1st “on” time - unit starts on Monday at 8:00



1st “off” time - unit starts on Monday at 12:00



2nd “on” time - unit starts on Monday at 14:00



2nd “off” time - unit stops on Monday at 18:00

Example 2 – Overlapping Blocks

MON

Time display

Temp Display



1st “on” time - unit starts on Monday at 8:00



1st “off” time - unit stops on Monday at 12:00



2nd “on” time – No action
Time programmed before 1st stop time, unit remains off



2nd “off” time - unit stops on Monday at 18:00
Time programmed before 1st stop time, unit remains off

Example 3 – Ignored times

MON

Time display

Temp Display



1st “on” time - unit starts on Monday at 8:00



1st “off” time - unit stops on Monday at 12:00



2nd “on” time – No action



2nd “off” time - unit stops on Monday at 18:00

CONTROLS

FAN SPEED SETTING

Press FAN SPEED button and hold for about 5 seconds to activate the Speed setting menu.

After entering menu, first speed setting is for Low speed for Exhaust fan. The speed can be adjusted in range 0-100 by pushing up button ▲ for increasing and down button ▼ for decreasing value that is shown where should be timer. After choosing value for Low speed, press OK button.

For Low speed, default value is 35.

After setting Low speed, now you will be offered to set Med speed for Exhaust fan. The speed can be adjusted in range 0-100% by pushing up button ▲ for increasing and down button ▼ for decreasing value expressed as a percentage. After choosing value for Med speed, press OK button.

For Med speed, default value is 60.

After setting Med speed, now you will be offered to set High speed for Exhaust fan. The speed can be adjusted in range 0-100% by pushing up button ▲ for increasing and down button ▼ for decreasing value expressed as a percentage. After choosing value for High speed, press OK button to continue with setting Supply fan speeds.

For High speed, default value is 100.

Process of setting speeds for Supply fan is same with process of setting speeds for Exhaust fan, except when designated speed for High speed is reached, and instead of pressing OK button once, you should do it 3 times to return to home screen.

IMPORTANT: If you want to choose different value then default value for any of the speeds, after every parameter change, measure with multimeter board output (in Volts AC) to avoid that fan work under 120V.

TROUBLESHOOTING

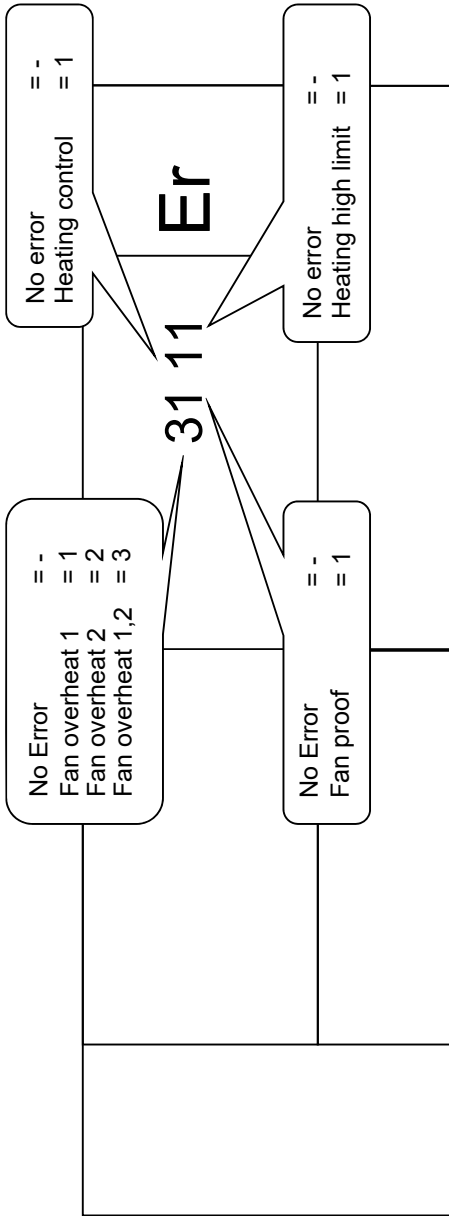

Errors on the system can be tested with 4 lines. Named errors are Fan overheat 1, Fan overheat 2, Fan proof, Heater Control and Heating high limit. Follow points to test the errors.

OVER 1	OVER 2	FAN	CTRL	HIGH	1	2	3	4
ON	ON	OFF	ON	ON				
ON	ON	OFF	ON	OFF	-	-	-	1
ON	ON	OFF	OFF	OFF	-	-	1	1
ON	ON	ON	OFF	OFF	-	1	1	1
ON	OFF	ON	OFF	OFF	1	1	1	1
OFF	ON	ON	OFF	OFF	2	1	1	1
OFF	OFF	ON	OFF	OFF	3	1	1	1

TROUBLESHOOTING

FAULT	REASON	SOLUTION
FANS DO NOT WORK	a. Power supply off	a. Turn on the power supply
	b. No signal from the control panel	b. Press the correct buttons of the control panel
	c. Incorrect or loose electrical connection	c. Connect connections correctly
	d. Motors in thermal protection mode *e. No signal from the frequency inverter	d. Check motor current *e. Check the error code on the frequency inverter's screen
FANS RETURN TO REVERSE DIRECTION	a. Phase and capacitor wires are mixed b. Phase connection is not correct	a. Make the correct wire connection b. Make the correct phase connection
LOW AIR FLOW	a. Filters clogged or dirty	a. Change or clean filters
	b. Air duct is clogged	b. Check the air ducts
	c. Channel connections are incomplete.	c. Check the duct system for leaks and complete the connections
HIGH AIR FLOW	a. Channel connections are incomplete.	a. Check the duct system for leaks and complete the connections
	b. Supply voltage is low	b. Measure the current drawn by the motor against overloading
	c. Grilles are not mounted	c. Mount the grilles
	d. Filters are not mounted	d. Mount the filters
DRAINAGE WATER CAN NOT BE DISCHARGED	a. Drainage plugged	a. Clean drain pipe
	b. Incorrect installation of drainage pipe.	b. Mount the drain pipe correctly

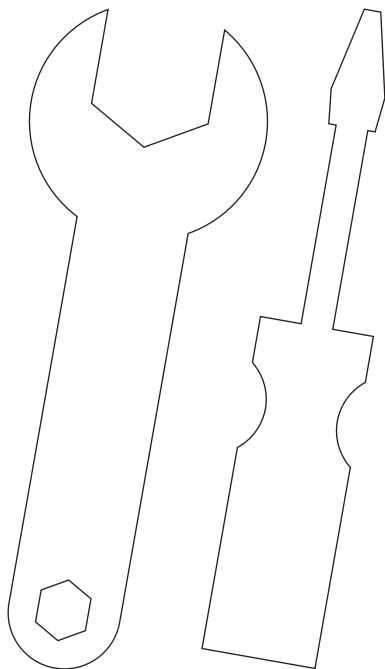

► For Troubleshooting **Please Contact**

Boulevard Zoran Djindjic, 80, 11070 Novi Beograd
Tel: +381 11 2600 901 • Fax: +381 11 2600 906
www.jakkagroup.com • jakkagroup@jakkagroup.com